

ST-JX301/JX401

SERVICE MANUAL

US Model
Canadian Model
E Model
ST-JX301

US Model
E Model
ST-JX401

- This model is almost the same as the model ST-JX295/JX390 previously produced. Therefore, see the ST-JX295/JX390 service manual for the information not contained in this service manual.
- ST-JX301 is the same ST-JX295.
- ST-JX401 is the same ST-JX390.

FM STEREO/FM-AM TUNER
SONY[®]

SAFETY CHECK-OUT

After correcting the original service problem, perform the following safety check before releasing the set to the customer:

Check the antenna terminals, metal trim, "metallized" knobs, screws, and all other exposed metal parts for AC leakage. Check leakage as described below.

LEAKAGE TEST

The AC leakage from any exposed metal part to earth ground and from all exposed metal parts to any exposed metal part having a return to chassis, must not exceed 0.5 mA (500 microamperes). Leakage current can be measured by any one of three methods.

1. A commercial leakage tester, such as the Simpson 229 or RCA WT-540A. Follow the manufacturers' instructions to use these instruments.
2. A battery-operated AC milliammeter. The Data Precision 245 digital multimeter is suitable for this job.
3. Measuring the voltage drop across a resistor by means of a VOM or battery-operated AC voltmeter. The "limit" indication is 0.75 V, so analog meters must have an accurate low-voltage scale. The Simpson 250 and Sanwa SH-63Trd are examples of a passive VOM that is suitable. Nearly all battery operated digital multimeters that have a 2V AC range are suitable. (See Fig. A)

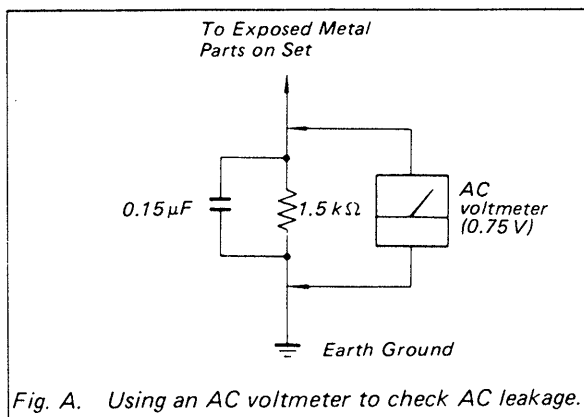

Fig. A. Using an AC voltmeter to check AC leakage.

SAFETY-RELATED COMPONENT WARNING!!



COMPONENTS IDENTIFIED BY MARK  OR DOTTED LINE WITH MARK  ON THE SCHEMATIC DIAGRAMS AND IN THE PARTS LIST ARE CRITICAL TO SAFE OPERATION. REPLACE THESE COMPONENTS WITH SONY PARTS WHOSE PART NUMBERS APPEAR AS SHOWN IN THIS MANUAL OR IN SUPPLEMENTS PUBLISHED BY SONY.

TABLE OF CONTENTS

<u>Section</u>	<u>Title</u>	<u>Page</u>
Safety Check-out		2
SECTION 1. DIAGRAMS		
1-1.	Semiconductor Lead Layouts	4
1-2.	Printed Wiring Boards	5
1-3.	Schematic Diagram (Tuner Section)	9
1-4.	FE1 (Front End) Schematic Diagram	11
1-5.	Waveforms	11
1-6.	Schematic Diagram (Control and Power Section)	12
SECTION 2. EXPLODED VIEW		
SECTION 3. ELECTRICAL PARTS LIST		
		16

To change the AM tuning interval

The AM tuning interval is preset at the factory to 10 kHz to match the frequency allocation system of your country. To change the interval to 9 kHz, proceed as follows.

- 1 Depress the POWER switch to turn on the unit.
- 2 Set the BAND FM/AM selector to AM.
- 3 Press the POWER switch to turn off the unit.
- 4 Hold the TUNING knob in the "+" position, and depress the POWER switch to turn on the unit. To reset the interval to 10 kHz, follow the same procedure.

Note

When the interval is changed, all preset stations which you have memorized using the numeric buttons will be erased from the memory. After changing the interval, be sure to preset the stations again.

ATTENTION AU COMPOSANT AYANT RAPPORT À LA SÉCURITÉ!

LES COMPOSANTS IDENTIFIÉS PAR UNE MARQUE  SUR LES DIAGRAMMES SCHÉMATIQUES ET LA LISTE DES PIÈCES SONT CRITIQUES POUR LA SÉCURITÉ DE FONCTIONNEMENT. NE REMPLACER CES COMPOSANTS QUE PAR DES PIÈCES SONY DONT LES NUMÉROS SONT DONNÉS DANS CE MANUEL OU DANS LES SUPPLÉMENTS PUBLIÉS PAR SONY.

SECTION 1 DIAGRAMS

2-1. SEMICONDUCTOR LEAD LAYOUTS

BA1L4M
2SC2785

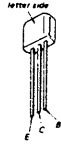

EQA02-30B
US1060M
10E2N

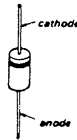

LA5667

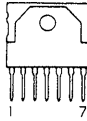

TMP47C670N-1282

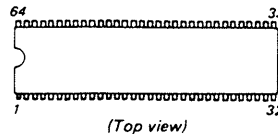

DTC114ES
2SA1348
2SC2669



LA1851N

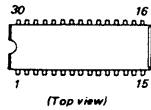

LC7218

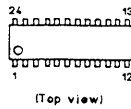

2SC3112



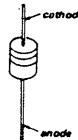

RD5.6ES-B2
UZL-6L2



2SK246GR3



Note :



- All capacitors are in μF unless otherwise noted. pF : μF 50 WV or less are not indicated except for electrolytics and tantalums.
- All resistors are in Ω and $\frac{1}{4}$ W or less unless otherwise specified.
- \triangle : internal component.
-  : nonflammable resistor.
-  : fusible resistor.

Note :

The components identified by mark \triangle or dotted line with mark \triangle are critical for safety. Replace only with part number specified.

Note :

Les composants identifiés par une marque \triangle sont critiques pour la sécurité. Ne les remplacer que par une pièce portant le numéro spécifié.

-  : B+ Line.
-  : B- Line.
-  : adjustment for repair.

- Voltage and waveforms are dc with respect to ground under no-signal (detuned) conditions.
- no mark : FM
- () : AM
- Voltage are taken with a VOM (Input impedance 10 M Ω). Voltage variations may be noted due to normal production tolerances.
- Waveforms are taken with a oscilloscope. Voltage variations may be noted due to normal production tolerances.
- Circled numbers refer to waveforms.
- Signal path. \Rightarrow : FM

[Service Note]

INDICATOR TUBE ALL LIGHT-UP MODE

When turning POWER switch on while pressing PRESET 1 and AUTO TUNING KEYS simultaneously, all the segments of FL701 will light.

2-2. PRINTED WIRING BOARDS

- Note:
- : parts extracted from the component side.
 - : indicates side identified with part number.
 - ▭ : Pattern on the side which is seen.

[Note on Inserting the Cord to the Connector on Tuner Board]

- Insert the cord to the connector fitting Pin ① of the cord in accordance with the white mark on the board at the connector as shown in the figure.

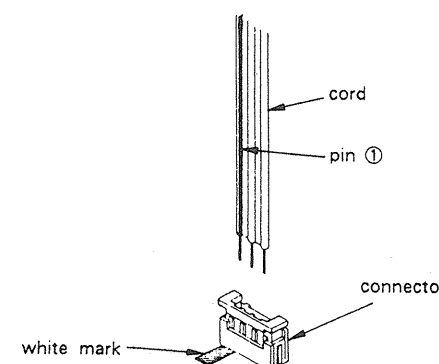

● Semiconductor Location

Ref. No.	Location	Ref. No.	Location
D21	H-8	D714	B-5
D22	H-8	D715	B-4
D23	H-8	D716	B-4
D24	H-8	D717	B-4
D501	F-15	D718	B-3
D502	F-15		
D503	G-15	IC21	H-6
D504	G-15	IC81	E-4
D505	G-14	IC501	E-15
D506	G-15	IC701	B-12
D507	E-12		
D601	H-10	Q1	G-4
D602	H-10	Q2	G-4
D603	G-12	Q21	F-7
D701	B-14	Q22	G-7
D702	B-10	Q26	I-7
D703	B-8	Q27	G-8
D707	B-3	Q28	H-8
D708	B-3	Q81	F-5
D709	B-3	Q82	F-5
D710	B-9	Q83	E-3
D711	B-8	Q84	E-2
D712	B-7	Q601	G-10
D713	B-6	Q602	G-10

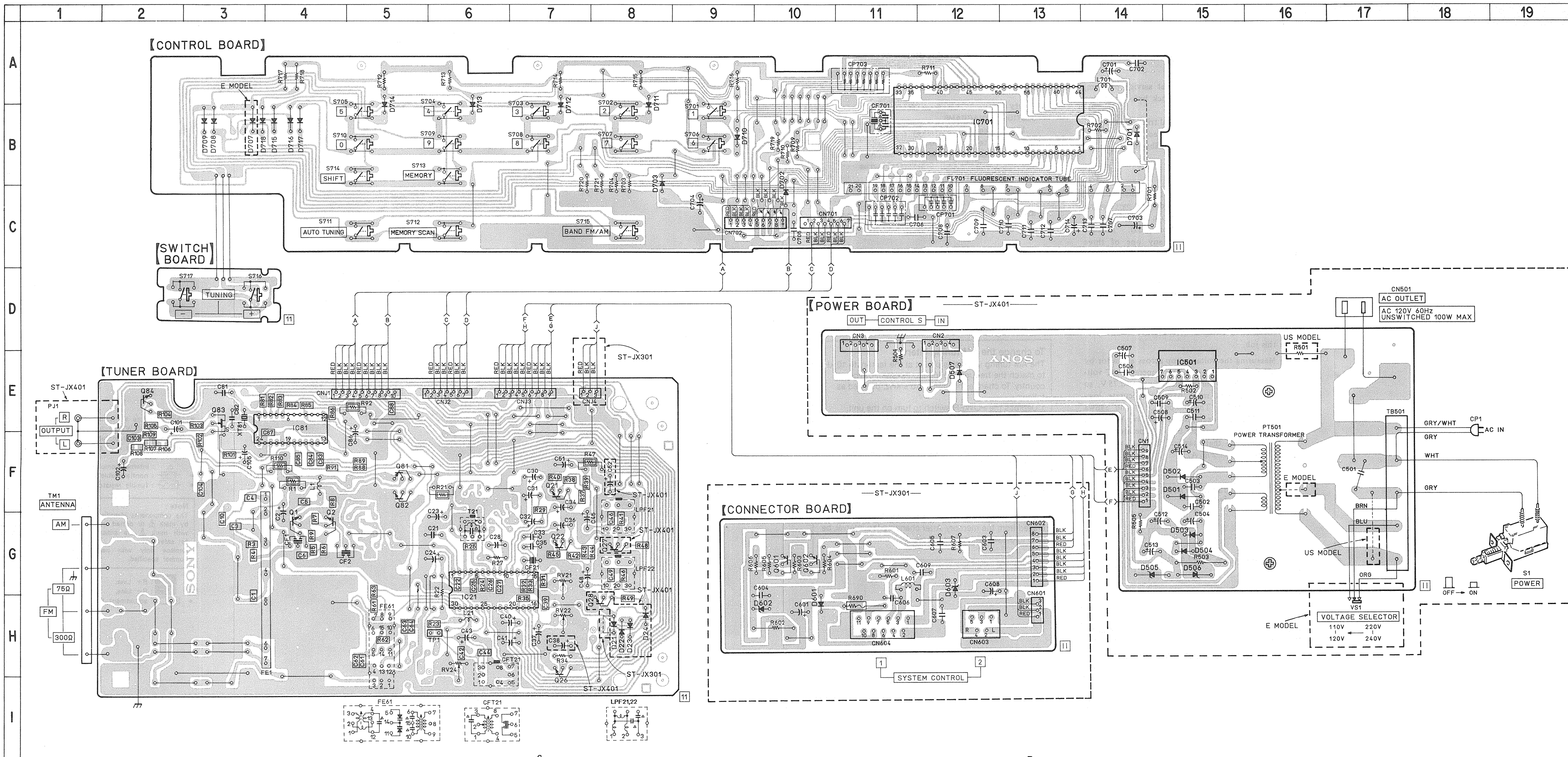

2-3. SCHEMATIC DIAGRAM - Tuner Section -

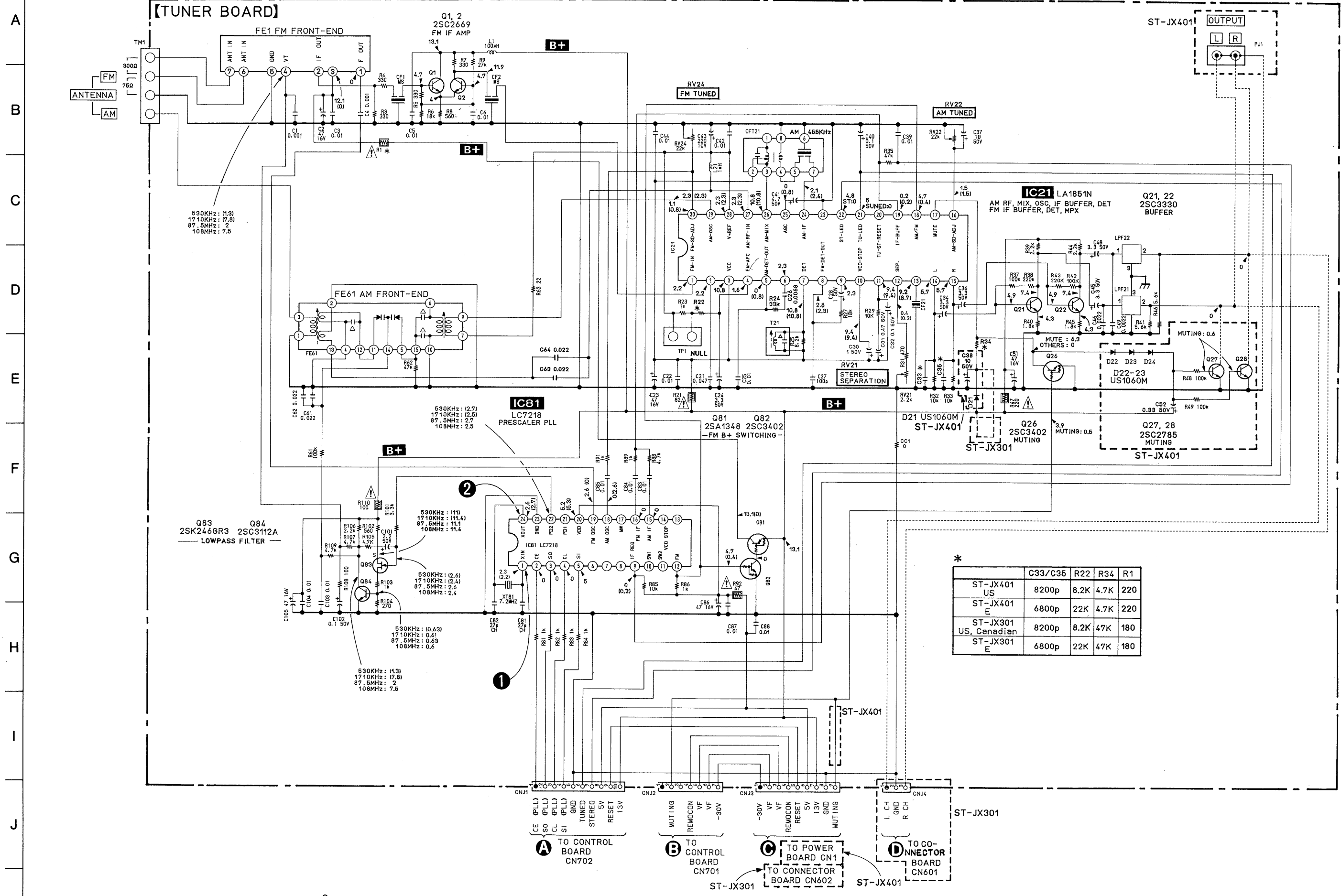

	C33/C35	R22	R34	R1
ST-JX401 US	8200p	8.2K	4.7K	220
ST-JX401 E	6800p	22K	4.7K	220
ST-JX301 US, Canadian	8200p	8.2K	47K	180
ST-JX301 E	6800p	22K	47K	180

2-4. FE1 (Front End) Schematic Diagram

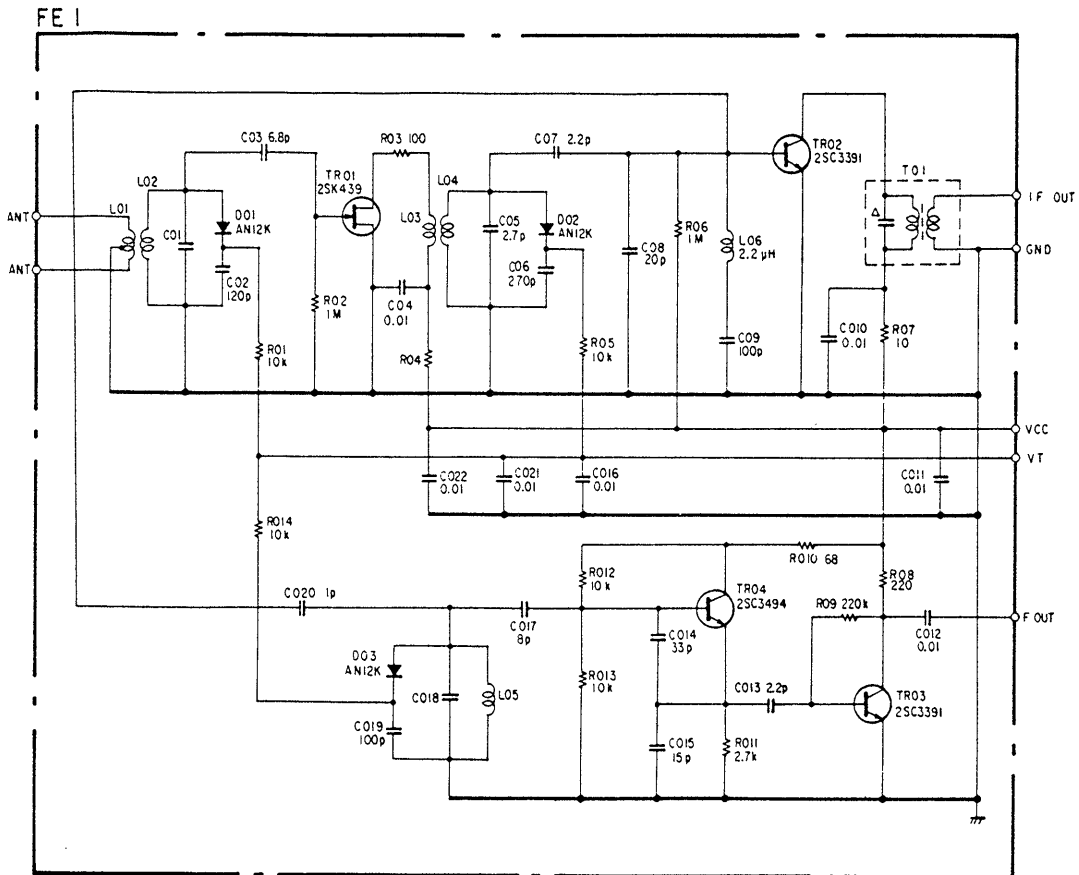

2-5. WAVEFORMS

No.	Wave Forms	No.	Wave Forms
①		③	
②		④	
		⑤	

2-6. SCHEMATIC DIAGRAM —Control and Power Section— • Refer to page 4 for note.

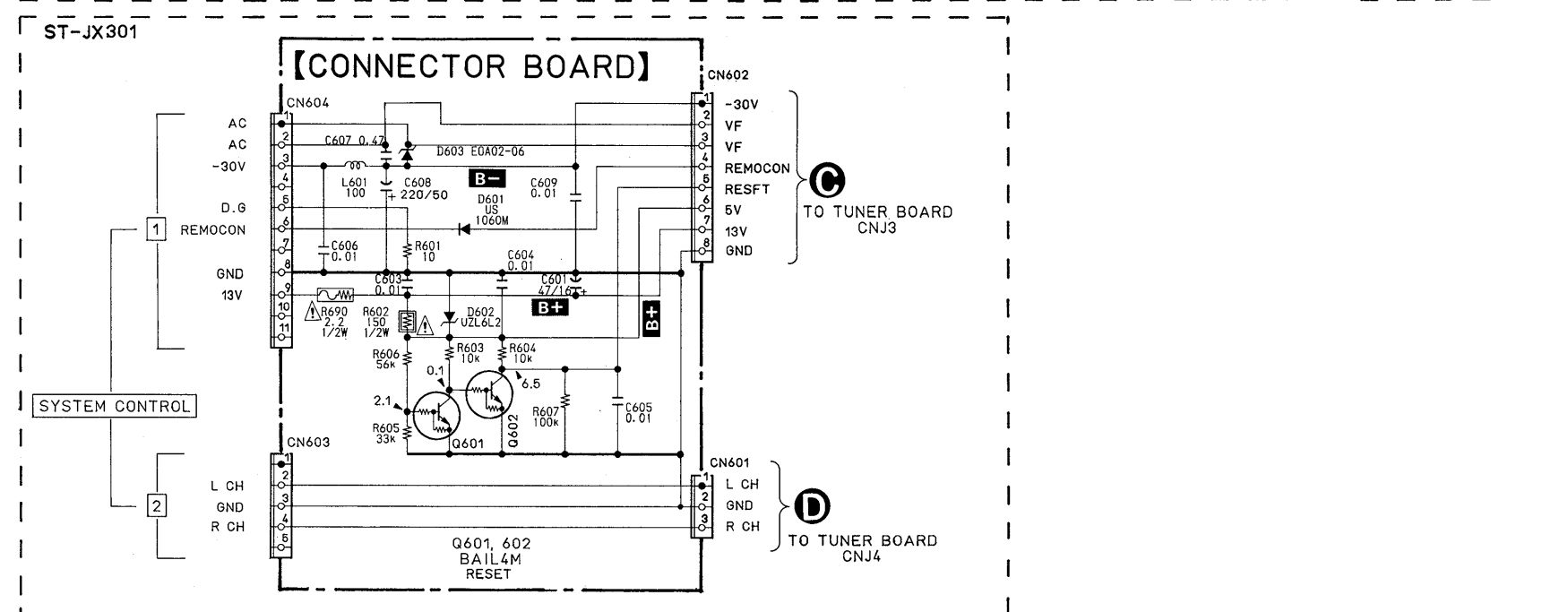
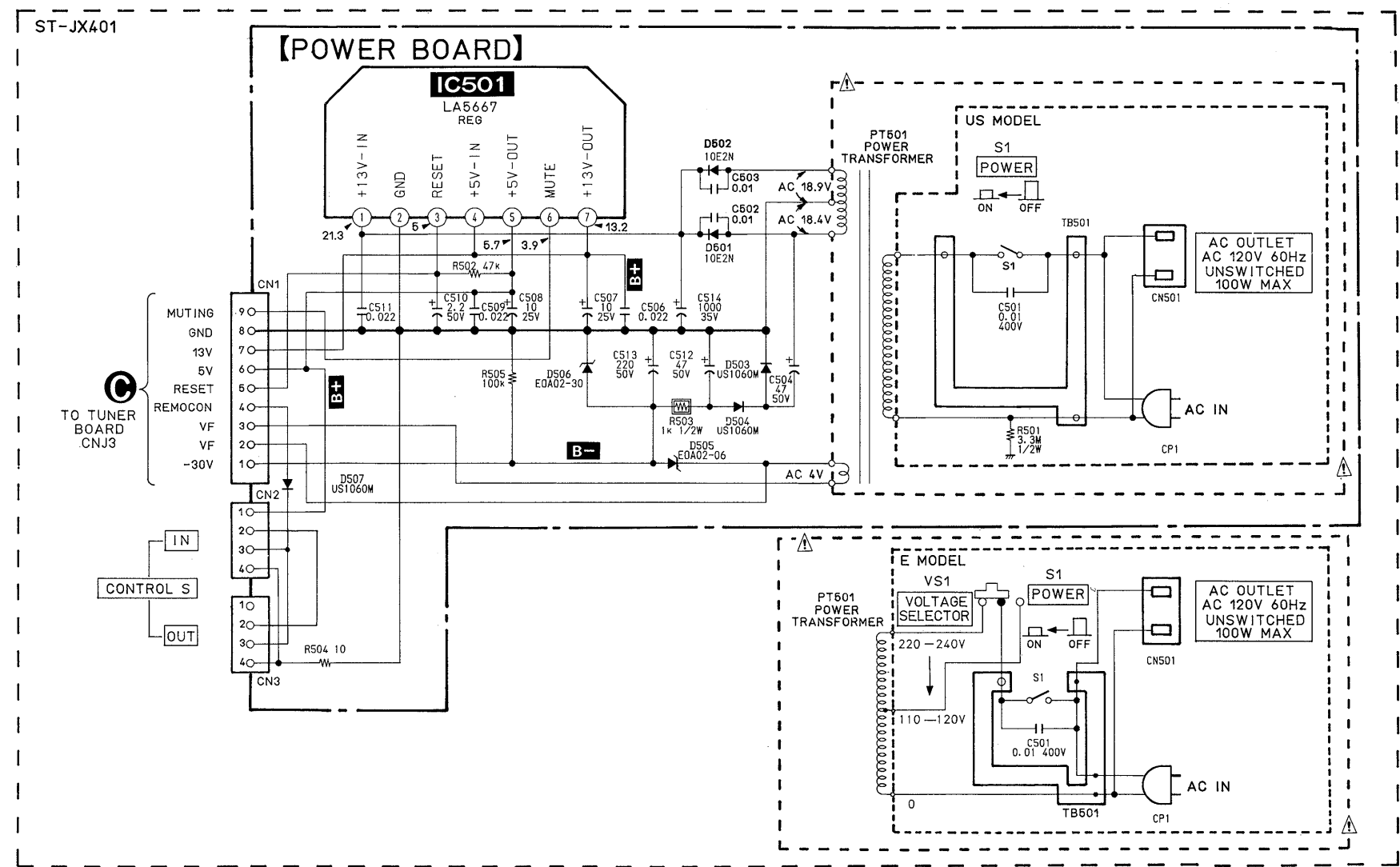
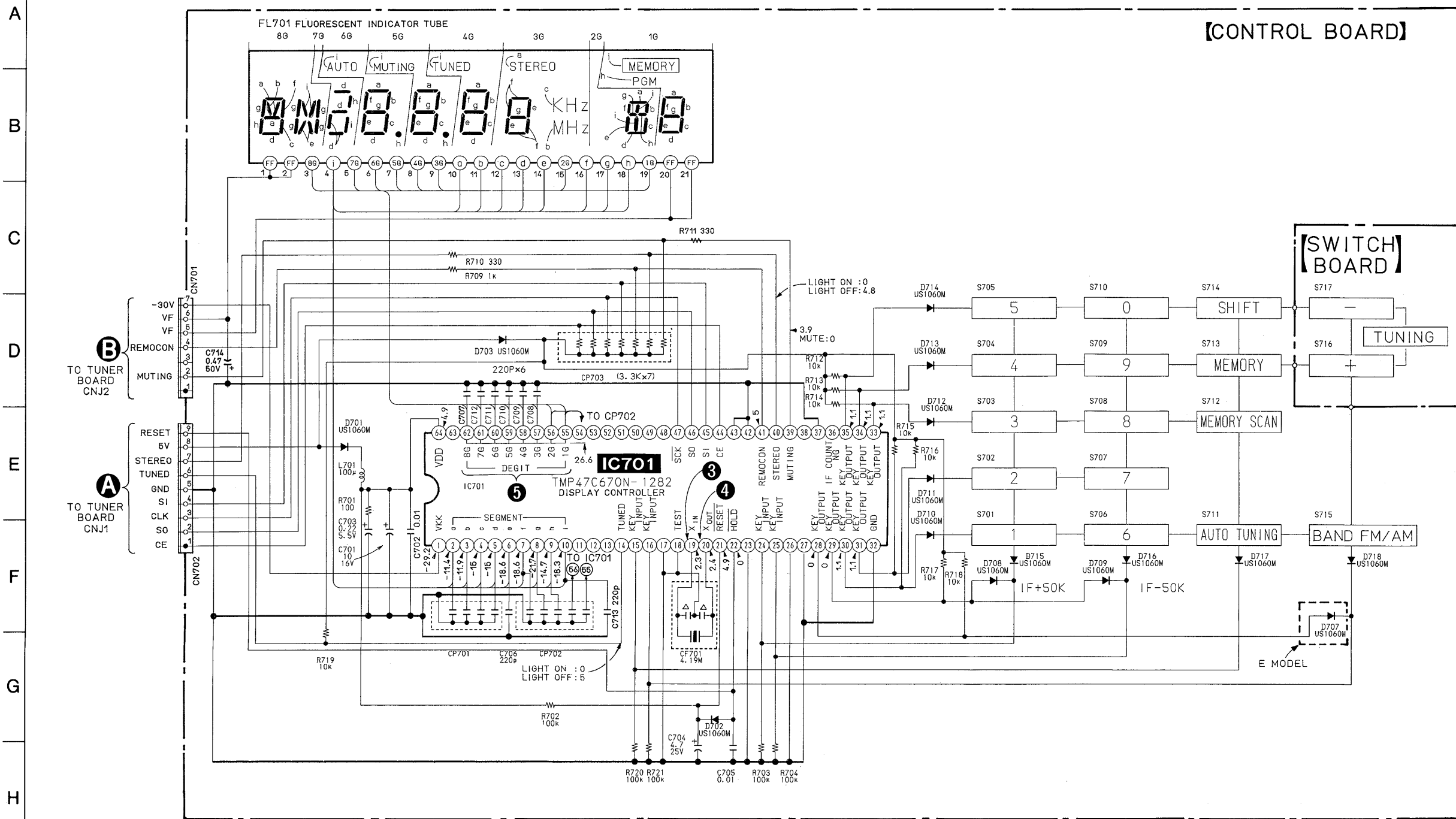

SECTION 2 EXPLODED VIEW

NOTE:

- The mechanical parts with no reference number in the exploded views are not supplied.
- The construction parts of an assembled part are indicated with a collation number in the remark column.
- Items marked "★" are not stocked since they are seldom required for routine service. Some delay should be anticipated when ordering these items.

- Due to standardization, parts with part number suffix -XX and -X may be different from the parts specified in the components used on the set.
- Color Indication of Appearance Parts
Example:
(RED) ... KNOB, BALANCE (WHITE)

↑ Cabinet's Color ↑ Parts' Color

The components identified by mark or dotted line with mark are critical for safety. Replace only with part number specified.

Les composants identifiés par une marque sont critiques pour la sécurité. Ne les remplacer que par une pièce portant le numéro spécifié.

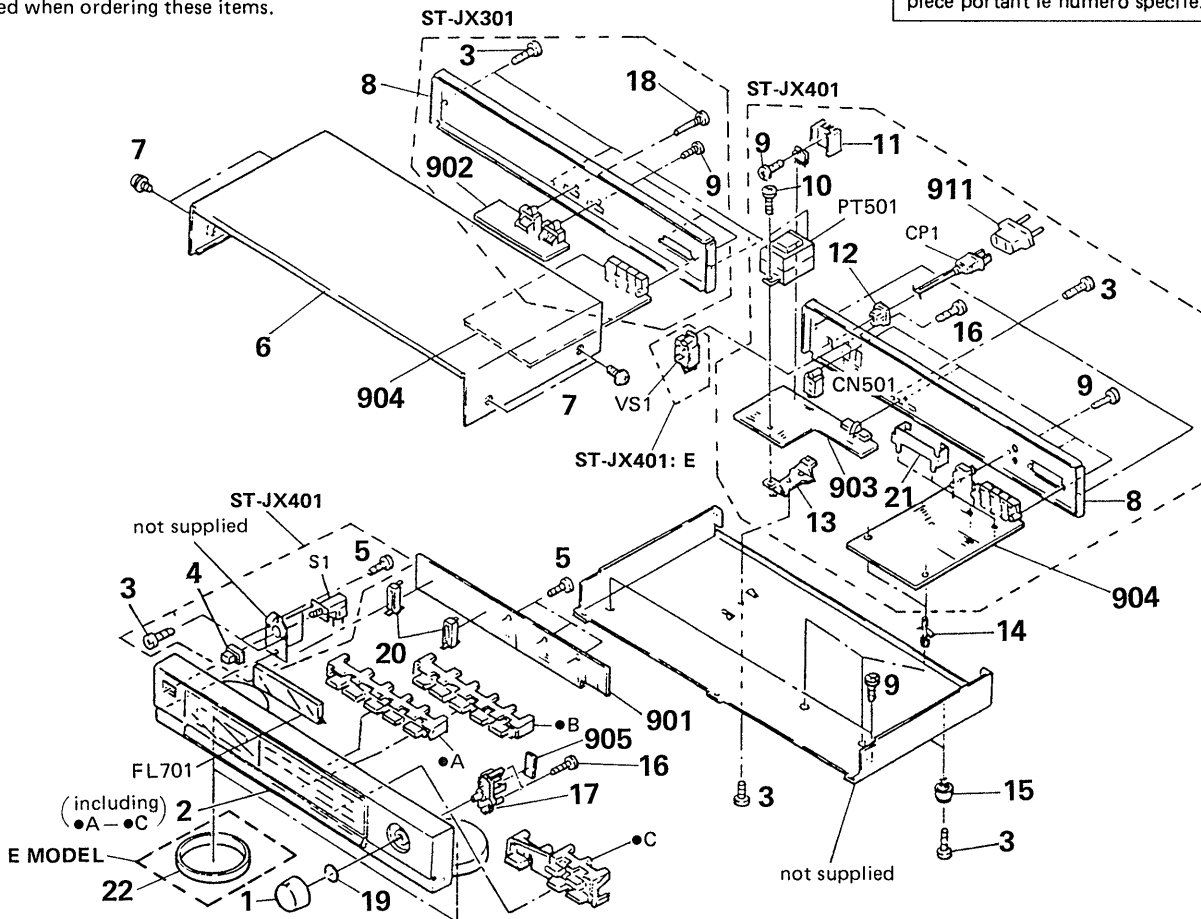

No.	Part No.	Description	Remarks	No.	Part No.	Description	Remarks
1	4-922-790-11	KNOB (TUNING)		901	*A-4334-193-A	(JX301:US,Canadian) ...MOUNTED PCB, CONTROL	
2	X-4905-267-1	(JX401:US)...PANEL ASSY, FRONT			*A-4334-194-A	(JX301:E)...MOUNTED PCB, CONTROL	
	X-4905-268-1	(JX301:US,Canadian)...PANEL ASSY, FRONT			*A-4334-198-A	(JX401:E)...MOUNTED PCB, CONTROL	
	X-4905-270-1	(JX301:E)...PANEL ASSY, FRONT			*A-4334-200-A	(JX401:US)...MOUNTED PCB, CONTROL	
	X-4905-271-1	(JX401:E)...PANEL ASSY, FRONT		902	*1-634-534-11	(JX301)...PC BOARD, CONNECTOR	
3	7-682-548-09	SCREW +BVTT 3X8 (S)		903	*1-634-531-11	(JX401)...PC BOARD, POWER	
4	3-354-912-01	(JX401)...KNOB, POWER		904	*A-4303-241-A	(JX301:E).....MOUNTED PCB, TUNER	
5	4-928-635-01	SCREW, +BV (2.6X8) TAPPING			*A-4303-242-A	(JX301:US,Canadian)...MOUNTED PCB, TUNER	
6	4-917-050-51	CASE			*A-4303-243-A	(JX401:E).....MOUNTED PCB, TUNER	
7	3-704-366-01	SCREW (CASE) (M3X8)			*A-4303-244-A	(JX401:US).....MOUNTED PCB, TUNER	
8	*4-917-071-01	(JX301).....PANEL, BACK		905	*1-634-532-11	(JX401)...PC BOARD, SWITCH	
	*4-917-072-01	(JX401:US)...PANEL, BACK			*1-634-535-11	(JX301)...PC BOARD, SWITCH	
	*4-917-072-11	(JX401:E)...PANEL, BACK		911	1-526-565-00	(JX401:E)...AC PLUG, ADAPTOR	
9	7-685-646-79	SCREW +BTP 3X8 TYPE2 N-S		CN501	1-540-038-11	(JX401:E)...OUTLET, AC (NONPOLAR)	
10	7-682-550-04	SCREW +BVTT 3X12 (S)		CN501	1-540-057-11	(JX401:US)...OUTLET, AC (POLAR)	
11	*4-363-146-31	(JX401)...HEAT SINK, V.OUT		CP1	1-558-945-11	(JX401:US)...CORD, POWER (POLAR.SPT-1)	
12	*3-703-571-11	(JX401)...BUSHING (S) (4516), CORD		CP1	1-551-188-XX	(JX401:E)...CORD, POWER	
13	*4-917-044-01	(JX401)...BRACKET (PT)		FL701	1-519-512-11	INDICATOR TUBE, FLUORESCENT	
14	*3-346-265-11	HOLDER, PC BOARD		PT501	1-450-008-11	(JX401:E)...TRANSFORMER, POWER	
15	4-927-849-01	FOOT		PT501	1-450-010-11	(JX401:US)...TRANSFORMER, POWER	
16	7-685-534-19	SCREW +BTP 2.6X8 TYPE2 N-S		S1	1-554-920-11	(JX401)...SWITCH, PUSH (AC POWER)(1 KEY)	
17	X-4905-269-1	SHAFT ASSY, TUNING		VS1	1-570-046-21	(JX401:E)...SWITCH, VOLTAGE CHANGE	
18	3-704-242-01	(JX301)...SCREW, TERMINAL, +BVTP CLAW					
19	3-350-426-01	SPRING					
20	*4-924-989-11	HOLDER (FL TUBE)					
21	*4-924-988-11	PLATE (ST), GROUND					
22	*4-929-030-11	(E)...RING, ORNAMENTAL					

SECTION 3 ELECTRICAL PARTS LIST

NOTE:

- Due to standardization, replacements in the parts list may be different from the parts specified in the diagrams or the components used on the set.
- Items marked "★" are not stocked since they are seldom required for routine service. Some delay should be anticipated when ordering these items.
- If there are two or more same circuits in a set such as a stereophonic machine, only typical circuit parts may be indicated and capacitors and resistors in other same circuits may be omitted.

CAPACITORS:

MF: μ F, PF: μ MF.

RESISTORS

- All resistors are in ohms.
- F: nonflammable

COILS

- MMH: mH, UH: μ H

SEMICONDUCTORS

In each case, U: μ , for example:

UA...: μ A..., UPA...: μ PA...,

UPC...: μ PC, UPD...: μ PD...

The components identified by mark Δ or dotted line with mark Δ are critical for safety. Replace only with part number specified.

Les composants identifiés par une marque Δ sont critiques pour la sécurité. Ne les remplacer que par une pièce portant le numéro spécifié.

Ref.No.	Part No.	Description	Ref.No.	Part No.	Description
901	*A-4334-193-A	(JX301:US,Canadian) ...MOUNTED PCB, CONTROL	C40	1-124-463-00	CAP, ELECT 0.1MF 20% 50V
	*A-4334-194-A	(JX301:E)...MOUNTED PCB, CONTROL	C41	1-124-045-00	CAP, ELECT 4.7MF 20% 50V
	*A-4334-198-A	(JX401:E)...MOUNTED PCB, CONTROL	C42	1-163-059-00	CERAMIC MELF 0.01MF 20% 16V
	*A-4334-200-A	(JX401:US)...MOUNTED PCB, CONTROL	C43	1-126-101-11	CAP, ELECT 220MF 20% 10V
902	*1-634-534-11	(JX301)...PC BOARD, CONNECTOR	C44	1-163-059-00	CERAMIC MELF 0.01MF 20% 16V
903	*1-634-531-11	(JX401)...PC BOARD, POWER	C45	1-126-162-11	CAP, ELECT 3.3MF 20% 50V
904	*A-4303-241-A	(JX301:E).....MOUNTED PCB, TUNER	C46	1-161-375-00	CERAMIC MELF 0.0022MF 20% 25V
	*A-4303-242-A	(JX301:US,Canadian) ...MOUNTED PCB, TUNER	C48	1-126-162-11	CAP, ELECT 3.3MF 20% 50V
	*A-4303-243-A	(JX401:E).....MOUNTED PCB, TUNER	C49	1-161-375-00	CERAMIC MELF 0.0022MF 20% 25V
	*A-4303-244-A	(JX401:US).....MOUNTED PCB, TUNER	C51	1-126-022-11	CAP, ELECT 47MF 20% 25V
905	*1-634-532-11	(JX401)...PC BOARD, SWITCH	C52	1-124-252-00	(JX401)...CAP,ELECT 0.33MF 20% 50V
	*1-634-535-11	(JX301)...PC BOARD, SWITCH	C61	1-163-063-00	CERAMIC MELF 0.022MF 25V
911	1-526-565-00	(JX401:E)...AC PLUG, ADAPTOR	C62	1-163-063-00	CERAMIC MELF 0.022MF 25V
C1	1-162-294-31	CERAMIC CHIP 0.001MF 20% 25V	C63	1-163-063-00	CERAMIC MELF 0.022MF 25V
C2	1-126-022-11	CAP, ELECT 47MF 20% 16V	C64	1-163-063-00	CERAMIC MELF 0.022MF 25V
C3	1-163-059-00	CERAMIC MELF 0.01MF 20% 16V	C81	1-102-961-00	CAP, CERAMIC 27PF 5% 50V
C4	1-162-294-31	CERAMIC CHIP 0.001MF 20% 25V	C82	1-102-961-00	CAP, CERAMIC 27PF 5% 50V
C5	1-163-059-00	CERAMIC MELF 0.01MF 20% 16V	C83	1-163-059-00	CERAMIC MELF 0.01MF 20% 16V
C6	1-163-059-00	CERAMIC MELF 0.01MF 20% 16V	C84	1-163-059-00	CERAMIC MELF 0.01MF 20% 16V
C21	1-161-021-11	CAP, CERAMIC 0.047MF 10% 25V	C85	1-163-059-00	CERAMIC MELF 0.01MF 20% 16V
C22	1-163-059-00	CERAMIC MELF 0.01MF 20% 16V	C86	1-126-022-11	CAP, ELECT 47MF 20% 25V
C23	1-126-022-11	CAP, ELECT 47MF 20% 25V	C87	1-163-059-00	CERAMIC MELF 0.01MF 20% 16V
C24	1-126-162-11	CAP, ELECT 3.3MF 20% 50V	C88	1-163-059-00	CERAMIC MELF 0.01MF 20% 16V
C25	1-163-059-00	CERAMIC MELF 0.01MF 20% 16V	C101	1-126-161-11	CAP, ELECT 2.2MF 20% 50V
C26	1-163-019-00	CERAMIC MELF 0.0068MF 20% 12V	C102	1-124-463-00	CAP, ELECT 0.1MF 20% 50V
C27	1-162-516-11	CERAMIC CHIP 100PF 10% 50V	C103	1-163-059-00	CERAMIC MELF 0.01MF 20% 16V
C28	1-126-301-11	CAP, ELECT 1.0MF 20% 50V	C104	1-163-059-00	CERAMIC MELF 0.01MF 20% 16V
C30	1-126-301-11	CAP, ELECT 1.0MF 20% 50V	C105	1-126-022-11	CAP, ELECT 47MF 20% 25V
C31	1-126-300-11	CAP, ELECT 0.47MF 20% 50V	C501	Δ 1-161-744-00	(JX401)...CERAMIC 0.01MF 400V
C32	1-124-463-00	CAP, ELECT 0.1MF 20% 50V	C502	1-101-004-00	(JX401)...CERAMIC 0.01MF 50V
C33	1-130-481-00	(JX401/JX301:E)...CAP,PE TEREPHTHALATE 00068MF 5% 50V	C503	1-101-004-00	(JX401)...CERAMIC 0.01MF 50V
C33	1-130-482-00	(JX401:US/JX301:US,Canadian)... CAP, PE TEREPHTHALATE 0.0082MF 5% 50V	C504	1-124-910-11	(JX401)...ELECT 47MF 20% 50V
C34	1-126-162-11	CAP, ELECT 3.3MF 20% 50V	C506	1-101-005-00	(JX401)...CERAMIC 0.022MF 50V
C35	1-130-481-00	(JX401/JX301:E)...CAP,PE TEREPHTHALATE 00068MF 5% 50V	C507	1-126-059-11	(JX401)...ELECT 10MF 20% 50V
C35	1-130-482-00	(JX401:US/JX301:US,Canadian)... CAP, PE TEREPHTHALATE 0.0082MF 5% 50V	C508	1-126-059-11	(JX401)...ELECT 10MF 20% 50V
C36	1-126-162-11	CAP, ELECT 3.3MF 20% 50V	C509	1-101-005-00	(JX401)...CERAMIC 0.022MF 50V
C37	1-126-059-11	CAP, ELECT 10MF 20% 50V	C510	1-126-161-11	(JX401)...ELECT 2.2MF 20% 50V
C38	1-123-875-11	(JX401)...CAP,ELECT 10MF 20% 50V	C511	1-101-005-00	(JX401)...CERAMIC 0.022MF 50V
C39	1-163-059-00	CERAMIC MELF 0.01MF 20% 16V	C512	1-124-910-11	(JX401)...ELECT 47MF 20% 50V
			C513	1-124-911-11	(JX401)...ELECT 220MF 20% 50V
			C514	1-126-105-11	(JX401)...ELECT 1000MF 20% 35V
			C601	1-126-022-11	(JX301)...ELECT 47MF 20% 25V
			C603	1-101-004-00	(JX301)...CERAMIC 0.01MF 20% 50V
			C604	1-101-004-00	(JX301)...CERAMIC 0.01MF 20% 50V
			C605	1-101-004-00	(JX301)...CERAMIC 0.01MF 20% 50V

Ref.No.	Part No.	Description	Ref.No.	Part No.	Description
C606	1-101-004-00	(JX301)...CERAMIC	D707	8-719-912-20	(JX401/JX301:E)...DIODE 1SS120
C607	1-136-745-11	(JX301)...FILM	D708	8-719-912-20	DIODE 1SS120
C608	1-124-911-11	(JX301)...ELECT	D709	8-719-912-20	DIODE 1SS120
C609	1-101-004-00	(JX301)...CERAMIC	D710	8-719-912-20	DIODE 1SS120
C701	1-126-157-11	ELECT 10MF	D711	8-719-912-20	DIODE 1SS120
C702	1-161-379-00	CERAMIC 0.01MF	D712	8-719-912-20	DIODE 1SS120
C703	1-125-486-11	CAP,DOUBLELAYEKS 0.22F	D713	8-719-912-20	DIODE 1SS120
C704	1-126-094-11	ELECT 4.7MF	D714	8-719-912-20	DIODE 1SS120
C705	1-161-379-00	CERAMIC 0.01MF	D715	8-719-912-20	DIODE 1SS120
C706	1-162-286-31	CERAMIC 220PF	D716	8-719-912-20	DIODE 1SS120
C707	1-162-286-31	CERAMIC 220PF	D717	8-719-912-20	DIODE 1SS120
C708	1-162-286-31	CERAMIC 220PF	D718	8-719-912-20	DIODE 1SS120
C709	1-162-286-31	CERAMIC 220PF	FE1	1-463-962-11	FRONT END, FM
C710	1-162-286-31	CERAMIC 220PF	FE61	1-236-461-11	ENCAPSULATED COMPONENT
C711	1-162-286-31	CERAMIC 220PF	FL701	1-519-512-11	INDICATOR TUBE, FLUORESCENT
C712	1-162-286-31	CERAMIC 220PF	IC21	8-759-821-45	IC LA1851N
C713	1-162-286-31	CERAMIC 220PF	IC81	8-759-820-91	IC LC7218
C714	1-124-465-00	CAP,ELECT 0.47MF	IC501	8-759-820-09	(JX401)...IC LA5667
CF1	1-567-389-11	FILTER, CERAMIC	IC701	8-759-234-35	IC TMP47C670N-1283
CF2	1-567-389-11	FILTER, CERAMIC	L1	1-408-421-00	MICRO INDUCTOR (100UH)
CF21	1-577-075-11	OSCILLATOR, CERAMIC	L21	1-410-494-11	MICRO INDUCTOR (1MMH)
CF701	1-577-101-11	VIBRATOR, CERAMIC	L601	1-408-421-00	(JX301)...INDUCTOR 100UH
CFT21	1-404-853-11	TRANSFORMER,IF (CERAMIC FILTER)	L701	1-410-521-11	INDUCTOR 100UH
CN1	*1-568-284-11	(JX401)...SOCKET, CONNECTOR 9P	LPF21	1-235-164-00	FILTER, LOW PASS
CN2	1-564-980-11	(JX401)...PIN, CONNECTOR 4P	LPF22	1-235-164-00	FILTER, LOW PASS
CN3	1-564-980-11	(JX401)...PIN, CONNECTOR 4P	PJ1	1-565-352-21	(JX401)...JACK, PIN 2P
CN501A	1-540-038-11	(JX401:E)...OUTLET, AC (NONPOLAR)	PT501A	1-450-008-11	(JX401:E)...TRANSFORMER, POWER
CN501B	1-540-057-11	(JX401:US)...OUTLET, AC (POLAR)	PT501B	1-450-010-11	(JX401:US)...TRANSFORMER, POWER
CN601	1-568-278-11	(JX301)...SOCKET, CONNECTOR 3P	Q1	8-729-230-XX	TRANSISTOR 2SC2669
CN602	1-568-283-11	(JX301)...SOCKET, CONNECTOR 8P	Q2	8-729-230-XX	TRANSISTOR 2SC2669
CN603	1-566-856-11	(JX301)...SOCKET, CONNECTOR 5P	Q21	8-729-119-78	TRANSISTOR 2SC2785-HFE
CN604	1-566-858-11	(JX301)...SOCKET, CONNECTOR 11P	Q22	8-729-119-78	TRANSISTOR 2SC2785-HFE
CN701	1-568-282-11	SOCKET, CONNECTOR 7P	Q26	8-729-900-80	TRANSISTOR DTC114ES
CN702	*1-568-284-11	SOCKET, CONNECTOR 9P	Q27	8-729-620-05	(JX401)...TRANSISTOR 2SC2603-EF
CNJ1	*1-568-276-11	SOCKET, CONNECTOR 10P	Q28	8-729-620-05	(JX401)...TRANSISTOR 2SC2603-EF
CNJ2	*1-568-311-21	SOCKET, CONNECTOR 7P	Q81	8-729-900-61	TRANSISTOR DTA114ES
CNJ3	*1-568-313-11	SOCKET, CONNECTOR 9P	Q82	8-729-900-80	TRANSISTOR DTC114ES
CNJ4	1-568-269-11	(JX301)...SOCKET, CONNECTOR 3P	Q83	8-729-202-67	TRANSISTOR 2SK246GR3
CP1	A.1-551-188-XX	(JX401:E)...CORD, POWER	Q84	8-729-230-93	TRANSISTOR 2SC3113-AB
CP1	A.1-558-945-11	(JX401:US)...CORD, POWER	Q601	8-729-900-89	(JX301)...TRANSISTOR DTC144ES
CP701	1-233-148-11	COMPOSITION CIRCUIT BLOCK	Q602	8-729-900-89	(JX301)...TRANSISTOR DTC144ES
D21	8-719-912-20	(JX401)...DIODE 1SS120	R1	A.1-249-408-11	(JX301)...RES, CARBON (SMALL) 180 5% 1/4W F
D22	8-719-912-20	(JX401)...DIODE 1SS120	R1	A.1-249-409-11	(JX401)...RES, CARBON (SMALL) 220 5% 1/4W F
D23	8-719-912-20	(JX401)...DIODE 1SS120	R3	1-249-329-11	CARBON MELF 330 5% 1/8W
D24	8-719-912-20	(JX401)...DIODE 1SS120	R4	1-249-329-11	CARBON MELF 330 5% 1/8W
D501	8-719-200-77	(JX401)...DIODE 10E2N	R5	1-249-329-11	CARBON MELF 330 5% 1/8W
D502	8-719-200-77	(JX401)...DIODE 10E2N	R6	1-249-350-11	CARBON MELF 18K 5% 1/8W
D503	8-719-912-20	(JX401)...DIODE 1SS120	R7	1-249-329-11	CARBON MELF 330 5% 1/8W
D504	8-719-912-20	(JX401)...DIODE 1SS120	R8	1-249-332-11	CARBON MELF 560 5% 1/8W
D505	8-719-912-81	(JX401)...DIODE EQA02-06C	R9	1-249-352-11	CARBON MELF 27K 5% 1/8W
D506	8-719-904-93	(JX401)...DIODE EQA02-30B	R21	A.1-249-404-00	RES, CARBON (SMALL) 82 5% 1/4W F
D507	8-719-912-20	(JX401)...DIODE 1SS120	R22	1-249-428-11	(JX401:US/JX301:US,Canadian) ...RES, CARBON (SMALL) 8.2K 5% 1/4W
D601	8-719-912-20	(JX301)...DIODE 1SS120	R22	1-249-433-11	(JX401/JX301:E) ...RES, CARBON (SMALL) 22K 5% 1/4W
D602	8-719-933-35	(JX301)...DIODE HZS6A3L			
D603	8-719-912-81	(JX301)...DIODE EQA02-06C			
D701	8-719-912-20	DIODE 1SS120			
D702	8-719-912-20	DIODE 1SS120			
D703	8-719-912-20	DIODE 1SS120			

Note:
The components identified by mark Δ or dotted line with mark Δ are critical for safety. Replace only with part number specified.

Note:
Les composants identifiés par une marque Δ sont critiques pour la sécurité. Ne les remplacer que par une pièce portant le numéro spécifié.

Ref.No.	Part No.	Description				
R23	1-249-335-11	CARBON MELF	1K	5%	1/8W	
R24	1-249-353-11	CARBON MELF	33K	5%	1/8W	
R25	1-249-346-11	CARBON MELF	8.2K	5%	1/8W	
R27	1-249-432-11	RES, CARBON (SMALL)	18K	5%	1/4W	
R29	1-249-347-11	CARBON MELF	10K	5%	1/8W	
R31	1-249-331-11	CARBON MELF	470	5%	1/8W	
R32	1-249-347-11	CARBON MELF	10K	5%	1/8W	
R33	1-249-347-11	CARBON MELF	10K	5%	1/8W	
R34	1-249-425-11	(JX401)..RES,CARBON(SMALL)	4.7K			
R34	1-249-437-11	(JX301)..RES,CARBON(SMALL)	47K	5%	1/4W	
R35	1-249-355-11	CARBON MELF	47K	5%	1/8W	
R37	1-249-359-11	CARBON MELF	100K	5%	1/8W	
R38	1-249-363-11	CARBON MELF	220K	5%	1/8W	
R39	1-249-339-11	CARBON MELF	2.2K	5%	1/8W	
R40	1-249-338-11	CARBON MELF	1.8K	5%	1/8W	
R41	1-249-344-11	CARBON MELF	5.6K	5%	1/8W	
R42	1-249-359-11	CARBON MELF	100K	5%	1/8W	
R43	1-249-363-11	CARBON MELF	220K	5%	1/8W	
R44	1-249-339-11	CARBON MELF	2.2K	5%	1/8W	
R45	1-249-338-11	CARBON MELF	1.8K	5%	1/8W	
R46	1-249-344-11	CARBON MELF	5.6K	5%	1/8W	
R47	△ 1-249-409-11	RES, CARBON (SMALL)	220	5%	1/4W	F
R48	1-249-359-11	(JX401)...CARBON MELF	100K	5%	1/8W	
R49	1-249-359-11	(JX301)...CARBON MELF	100K	5%	1/8W	
R61	1-249-359-11	CARBON MELF	100K	5%	1/8W	
R62	1-249-355-11	CARBON MELF	47K	5%	1/8W	
R63	1-249-315-11	CARBON MELF	22	5%	1/8W	
R81	1-249-335-11	CARBON MELF	1K	5%	1/8W	
R82	1-249-335-11	CARBON MELF	1K	5%	1/8W	
R83	1-249-335-11	CARBON MELF	1K	5%	1/8W	
R84	1-249-335-11	CARBON MELF	1K	5%	1/8W	
R85	1-249-347-11	CARBON MELF	10K	5%	1/8W	
R86	1-249-335-11	CARBON MELF	1K	5%	1/8W	
R88	1-249-343-11	CARBON MELF	4.7K	5%	1/8W	
R89	1-249-335-11	CARBON MELF	1K	5%	1/8W	
R91	1-249-335-11	CARBON MELF	1K	5%	1/8W	
R92	△ 1-249-401-11	RES, CARBON (SMALL)	47	5%	1/4W	F
R101	1-249-341-11	CARBON MELF	3.3K	5%	1/8W	
R102	1-249-332-11	CARBON MELF	560	5%	1/8W	
R103	1-249-335-11	CARBON MELF	1K	5%	1/8W	
R104	1-249-328-11	CARBON MELF	270	5%	1/8W	
R105	1-249-343-11	CARBON MELF	4.7K	5%	1/8W	
R106	1-249-339-11	CARBON MELF	2.2K	5%	1/8W	
R107	1-249-343-11	CARBON MELF	4.7K	5%	1/8W	
R108	1-249-323-11	CARBON MELF	100	5%	1/8W	
R109	1-249-343-11	CARBON MELF	4.7K	5%	1/8W	
R110	△ 1-249-405-11	RES, CARBON (SMALL)	100	5%	1/4W	F
R501	1-202-725-00	(JX401:US)...SOLID	3.3M	10%	1/2W	
R502	1-249-437-11	(JX401)...CARBON	47K	5%	1/4W	
R503	△ 1-247-752-11	(JX401)...CARBON	1K	5%	1/2W	F
R504	1-249-393-11	(JX401)...CARBON	10	5%	1/4W	
R505	1-249-441-11	(JX401)...CARBON	100K	5%	1/4W	
R601	1-249-393-11	(JX301)...CARBON	10	5%	1/4W	
R602	△ 1-247-741-11	(JX301)...CARBON	150	5%	1/2W	
R603	1-249-429-11	(JX301)...CARBON	10K	5%	1/4W	
R604	1-249-429-11	(JX301)...CARBON	10K	5%	1/4W	
R605	1-249-435-11	(JX301)...CARBON	33K	5%	1/4W	
R606	1-249-438-11	(JX301)...CARBON	56K	5%	1/4W	
R607	1-249-441-11	(JX301)...CARBON	100K	5%	1/4W	

Ref.No.	Part No.	Description				
R690	△ 1-212-942-00	(JX301)...FUSIBLE	2.2	5%	1/2W	
R701	1-249-405-11	CARBON	100	5%	1/4W	
R702	1-249-441-11	CARBON	100K	5%	1/4W	
R703	1-249-441-11	CARBON	100K	5%	1/4W	
R704	1-249-441-11	CARBON	100K	5%	1/4W	
R709	1-249-417-11	CARBON	1K	5%	1/4W	
R710	1-249-411-11	CARBON	330	5%	1/4W	
R711	1-249-411-11	CARBON	330	5%	1/4W	
R712	1-249-429-11	CARBON	10K	5%	1/4W	
R713	1-249-429-11	CARBON	10K	5%	1/4W	
R714	1-249-429-11	CARBON	10K	5%	1/4W	
R715	1-249-429-11	CARBON	10K	5%	1/4W	
R716	1-249-429-11	CARBON	10K	5%	1/4W	
R717	1-249-429-11	CARBON	10K	5%	1/4W	
R718	1-249-429-11	CARBON	10K	5%	1/4W	
R719	1-249-429-11	CARBON	10K	5%	1/4W	
R720	1-249-441-11	CARBON	100K	5%	1/4W	
R721	1-249-441-11	CARBON	100K	5%	1/4W	
RV21	1-238-013-11	RES, ADJ, CARBON	2.2K			
RV22	1-238-017-11	RES, ADJ, CARBON	22K			
RV24	1-238-017-11	RES, ADJ, CARBON	22K			
S1	△ 1-554-920-11	(JX401)..SWITCH, PUSH(AC POWER)(1 KEY)				
S701	1-554-303-21	SWITCH, KEY BOARD (1)				
S702	1-554-303-21	SWITCH, KEY BOARD (2)				
S703	1-554-303-21	SWITCH, KEY BOARD (3)				
S704	1-554-303-21	SWITCH, KEY BOARD (4)				
S705	1-554-303-21	SWITCH, KEY BOARD (5)				
S706	1-554-303-21	SWITCH, KEY BOARD (6)				
S707	1-554-303-21	SWITCH, KEY BOARD (7)				
S708	1-554-303-21	SWITCH, KEY BOARD (8)				
S709	1-554-303-21	SWITCH, KEY BOARD (9)				
S710	1-554-303-21	SWITCH, KEY BOARD (0)				
S711	1-554-303-21	SWITCH, KEY BOARD (AUTO TUNING)				
S712	1-554-303-21	SWITCH, KEY BOARD (MEMORY SCAN)				
S713	1-554-303-21	SWITCH, KEY BOARD (MEMORY)				
S714	1-554-303-21	SWITCH, KEY BOARD (SHIFT)				
S715	1-554-303-21	SWITCH, KEY BOARD (BAND FM/AM)				
S716	1-554-303-21	SWITCH, KEY BOARD (TUNING +)				
S717	1-554-303-21	SWITCH, KEY BOARD (TUNING -)				
T21	1-404-807-11	TRANSFORMER, DISCRIMINATOR				
TB501	*1-535-141-00	(JX401:US)..BASE POST 22MM(10MM PITCH)4P				
TB501	*1-535-142-00	(JX401:E)..BASE POST 22MM(10MM PITCH)5P				
TM1	1-537-238-21	TERMINAL BOARD, PUSH 4P				
TP1	*1-560-060-00	PIN, CONNECTOR 2P				
VS1	△ 1-570-046-21	(JX401:E)...SWITCH, VOLTAGE CHANGE				
XT81	1-577-126-11	VIBRATOR, CRYSTAL				

Note:
The components identified by mark △ or dotted line with mark △ are critical for safety. Replace only with part number specified.

Note:
Les composants identifiés par une marque △ sont critiques pour la sécurité. Ne les remplacer que par une pièce portant le numéro spécifié.

ACCESSORY & PACKING MATERIAL

1-501-374-11 (JX401)...ANTENNA, LOOP
1-558-232-11 (JX401)...ACORD(WITH CONNECTOR)(SIRCS)4P
1-559-533-11 (JX401)...CORD, CONNECTION

3-751-442-11 (JX401:E)...MANUAL, INSTRUCTION
3-751-442-21 (JX401:US)...MANUAL, INSTRUCTION

*4-917-074-01 CUSHION
*4-917-075-01 (JX401)...INDIVIDUAL CARTON

